



Main

| | |
|------------------------------|------------------------------------|
| Range of product | Altivar 212 |
| Product or component type | Variable speed drive |
| Device short name | ATV212 |
| Product destination | Asynchronous motors |
| Product specific application | Pumps and fans in HVAC |
| Assembly style | With heat sink |
| Network number of phases | 3 phases |
| Motor power kW | 22 kW |
| Motor power hp | 30 hp |
| [Us] rated supply voltage | 380...480 V - 15...10 % |
| Supply voltage limits | 323...528 V |
| Supply frequency | 50...60 Hz - 5...5 % |
| EMC filter | Class C2 EMC filter integrated |
| Line current | 33.1 A at 480 V 41.6 A at 380 V |

Complementary

| | |
|------------------------------------|--|
| Apparent power | 33.2 kVA at 380 V |
| Prospective line I _{sc} | 22 kA |
| Continuous output current | 43.5 A at 380 V 43.5 A at 460 V |
| Maximum transient current | 47.9 A for 60 s |
| Speed drive output frequency | 0.5...200 Hz |
| Nominal switching frequency | 8 kHz |
| Switching frequency | 6...16 kHz adjustable 8...16 kHz with derating factor |
| Speed range | 1...10 |
| Speed accuracy | +/- 10 % of nominal slip 0.2 T _n to T _n |
| Torque accuracy | +/- 15 % |
| Transient overtorque | 120 % of nominal motor torque +/- 10 % for 60 s |
| Asynchronous motor control profile | Voltage/Frequency ratio, 2 points Voltage/Frequency ratio - Energy Saving, quadratic U/f Voltage/Frequency ratio, automatic IR compensation (U/f + automatic U ₀) Flux vector control without sensor, standard Voltage/frequency ratio, 5 points |
| Regulation loop | Adjustable PI regulator |
| Motor slip compensation | Adjustable Not available in voltage/frequency ratio motor control Automatic whatever the load |
| Local signalling | 1 LED (red) for DC bus energized |
| Output voltage | <= power supply voltage |
| Isolation | Electrical between power and control |
| Type of cable | Without mounting kit: 1 wire(s)IEC cable at 45 °C, copper 90 °C / XLPE/EPR Without mounting kit: 1 wire(s)IEC cable at 45 °C, copper 70 °C / PVC With UL Type 1 kit: 3 wire(s)UL 508 cable at 40 °C, copper 75 °C / PVC |
| Electrical connection | VIA, VIB, FM, FLA, FLB, FLC, RY, RC, F, R, RES: terminal 2.5 mm ² / AWG 14 L1/R, L2/S, L3/T: terminal 50 mm ² / AWG 1/0 |

The information provided in this documentation contains general descriptions and/or technical characteristics of the performance of the products contained herein. This documentation is not intended as a substitute for and is not to be used for determining suitability or reliability of these products for specific user applications. It is the duty of any such user or integrator to perform the appropriate and complete risk analysis, evaluation and testing of the products with respect to the relevant specific application or use thereof. Neither Schneider Electric Industries SAS nor any of its affiliates or subsidiaries shall be responsible or liable for misuse of the information contained herein.

| | |
|-------------------------------------|---|
| Tightening torque | 0.6 N.M (VIA, VIB, FM, FLA, FLB, FLC, RY, RC, F, R, RES) 24 N.m, 212 lb.in (L1/R, L2/S, L3/T) |
| Supply | Internal supply for reference potentiometer (1 to 10 kOhm): 10.5 V DC +/- 5 %, <10 A, protection type: overload and short-circuit protection Internal supply: 24 V DC (21...27 V), <200 A, protection type: overload and short-circuit protection |
| Analogue input number | 2 |
| Analogue input type | VIA switch-configurable voltage: 0...10 V DC 24 V max, impedance: 30000 Ohm, resolution 10 bits VIB configurable voltage: 0...10 V DC 24 V max, impedance: 30000 Ohm, resolution 10 bits VIB configurable PTC probe: 0...6 probes, impedance: 1500 Ohm VIA switch-configurable current: 0...20 mA, impedance: 250 Ohm, resolution 10 bits |
| Sampling duration | 2 Ms +/- 0.5 ms F discrete 2 Ms +/- 0.5 ms R discrete 2 Ms +/- 0.5 ms RES discrete 3.5 Ms +/- 0.5 ms VIA analog 22 ms +/- 0.5 ms VIB analog |
| Response time | FM 2 ms, tolerance +/- 0.5 ms for analog output(s) FLA, FLC 7 ms, tolerance +/- 0.5 ms for discrete output(s) FLB, FLC 7 ms, tolerance +/- 0.5 ms for discrete output(s) RY, RC 7 ms, tolerance +/- 0.5 ms for discrete output(s) |
| Accuracy | +/- 0.6 % (VIA) for a temperature variation 60 °C +/- 0.6 % (VIB) for a temperature variation 60 °C +/- 1 % (FM) for a temperature variation 60 °C |
| Linearity error | VIA: +/- 0.15 % of maximum value for input VIB: +/- 0.15 % of maximum value for input FM: +/- 0.2 % for output |
| Analogue output number | 1 |
| Analogue output type | FM switch-configurable voltage 0...10 V DC, impedance: 7620 Ohm, resolution 10 bits FM switch-configurable current 0...20 mA, impedance: 970 Ohm, resolution 10 bits |
| Discrete output number | 2 |
| Discrete output type | Configurable relay logic: (FLA, FLC) NO - 100000 cycles Configurable relay logic: (FLB, FLC) NC - 100000 cycles Configurable relay logic: (RY, RC) NO - 100000 cycles |
| Minimum switching current | 3 mA at 24 V DC for configurable relay logic |
| Maximum switching current | 5 A at 250 V AC on resistive load - cos phi = 1 - L/R = 0 ms (FL, R) 5 A at 30 V DC on resistive load - cos phi = 1 - L/R = 0 ms (FL, R) 2 A at 250 V AC on inductive load - cos phi = 0.4 - L/R = 7 ms (FL, R) 2 A at 30 V DC on inductive load - cos phi = 0.4 - L/R = 7 ms (FL, R) |
| Discrete input type | F programmable 24 V DC, with level 1 PLC, impedance: 4700 Ohm R programmable 24 V DC, with level 1 PLC, impedance: 4700 Ohm RES programmable 24 V DC, with level 1 PLC, impedance: 4700 Ohm |
| Discrete input logic | Positive logic (source) (F, R, RES), <= 5 V (state 0), >= 11 V (state 1) Negative logic (sink) (F, R, RES), >= 16 V (state 0), <= 10 V (state 1) |
| Acceleration and deceleration ramps | Automatic based on the load Linear adjustable separately from 0.01 to 3200 s |
| Braking to standstill | By DC injection |
| Protection type | Overheating protection: drive Thermal power stage: drive Short-circuit between motor phases: drive Input phase breaks: drive Overcurrent between output phases and earth: drive Overvoltages on the DC bus: drive Break on the control circuit: drive Against exceeding limit speed: drive Line supply overvoltage and undervoltage: drive Line supply undervoltage: drive Against input phase loss: drive Thermal protection: motor Motor phase break: motor With PTC probes: motor |
| Dielectric strength | 3535 V DC between earth and power terminals 5092 V DC between control and power terminals |
| Insulation resistance | >= 1 mOhm 500 V DC for 1 minute |
| Frequency resolution | Display unit: 0.1 Hz Analog input: 0.024/50 Hz |

| | |
|--|---|
| Communication port protocol | Modbus LonWorks APOGEE FLN BACnet METASYS N2 |
| Connector type | 1 RJ45 1 open style |
| Physical interface | 2-wire RS 485 |
| Transmission frame | RTU |
| Transmission rate | 9600 bps or 19200 bps |
| Data format | 8 bits, 1 stop, odd even or no configurable parity |
| Type of polarization | No impedance |
| Number of addresses | 1...247 |
| Communication service | Write single register (06) Read device identification (43) Read holding registers (03) 2 words maximum Write multiple registers (16) 2 words maximum Time out setting from 0.1 to 100 s Monitoring inhibitable |
| Option card | Communication card for LonWorks |
| Operating position | Vertical +/- 10 degree |
| Width | 240 mm |
| Height | 420 mm |
| Depth | 214 mm |
| Net weight | 26.4 kg |
| Power dissipation in W | 626 W |
| Air flow | 214 m3/h |
| Functionality | Mid |
| Specific application | HVAC |
| IP degree of protection | IP21 |
| Variable speed drive application selection | Compressor for scroll Building - HVAC Fan Building - HVAC Pump Building - HVAC |
| Motor power range AC-3 | 15...25 KW at 380...440 V 3 phases 15...25 kW at 480...500 V 3 phases |
| Motor starter type | Variable speed drive |

Environment

| | |
|-------------------------------|---|
| Electromagnetic compatibility | Electrostatic discharge immunity test level 3 conforming to IEC 61000-4-2 Radiated radio-frequency electromagnetic field immunity test level 3 conforming to IEC 61000-4-3 Electrical fast transient/burst immunity test level 4 conforming to IEC 61000-4-4 1.2/50 µs - 8/20 µs surge immunity test level 3 conforming to IEC 61000-4-5 Conducted radio-frequency immunity test level 3 conforming to IEC 61000-4-6 Voltage dips and interruptions immunity test conforming to IEC 61000-4-11 |
| Pollution degree | 3 conforming to IEC 61800-5-1 |
| IP degree of protection | IP20 on upper part without blanking plate on cover conforming to EN/IEC 61800-5-1 IP20 on upper part without blanking plate on cover conforming to EN/IEC 60529 IP21 conforming to EN/IEC 61800-5-1 IP21 conforming to EN/IEC 60529 IP41 on upper part conforming to EN/IEC 61800-5-1 IP41 on upper part conforming to EN/IEC 60529 |
| Vibration resistance | 1.5 mm (f= 3...13 Hz) conforming to EN/IEC 60068-2-6 1 gn (f= 13...200 Hz) conforming to EN/IEC 60068-2-8 |
| Shock resistance | 15 gn for 11 ms conforming to IEC 60068-2-27 |
| Environmental characteristic | Classes 3C1 conforming to IEC 60721-3-3 Classes 3S2 conforming to IEC 60721-3-3 |
| Noise level | 59.9 dB conforming to 86/188/EEC |
| Operating altitude | 1000...3000 m limited to 2000 m for the Corner Grounded distribution network with current derating 1 % per 100 m <= 1000 m without derating |
| Relative humidity | 5...95 % without condensation conforming to IEC 60068-2-3 5...95 % without dripping water conforming to IEC 60068-2-3 |

| | |
|---------------------------------------|---|
| Ambient air temperature for operation | -10...40 °C (without derating) 40...50 °C (with derating factor) |
| Ambient air temperature for storage | -25...70 °C |
| Standards | EN 61800-3 environments 1 category C2 IEC 61800-3 environments 1 category C2 EN 61800-3 category C3 EN 61800-3 category C2 IEC 61800-3 EN 61800-3 environments 2 category C2 IEC 61800-5-1 EN 61800-3 environments 1 category C3 EN 61800-3 environments 2 category C3 IEC 61800-3 environments 1 category C1 IEC 61800-3 category C3 IEC 61800-3 environments 2 category C3 IEC 61800-3 category C2 EN 61800-3 environments 2 category C1 EN 61800-3 IEC 61800-3 environments 1 category C3 EN 61800-5-1 IEC 61800-3 environments 2 category C2 UL Type 1 EN 61800-3 environments 1 category C1 EN 55011 class A group 1 IEC 61800-3 environments 2 category C1 |
| Product certifications | C-Tick UL NOM 117 CSA |
| Marking | CE |

Offer Sustainability

| | |
|----------------------------|---|
| Sustainable offer status | Green Premium product |
| REACH Regulation | REACH Declaration |
| EU RoHS Directive | Pro-active compliance (Product out of EU RoHS legal scope) EU RoHS Declaration |
| Mercury free | Yes |
| RoHS exemption information | Yes |
| China RoHS Regulation | China RoHS Declaration |
| Environmental Disclosure | Product Environmental Profile |
| Circularity Profile | End Of Life Information |
| WEEE | The product must be disposed on European Union markets following specific waste collection and never end up in rubbish bins |

Contractual warranty

| | |
|----------|-----------|
| Warranty | 18 months |
|----------|-----------|

Dimensions

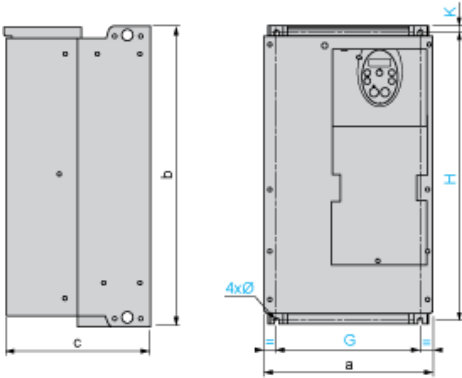

Dimensions in mm

| ATV212H | a | b | c | G | H | K | Ø |
|------------------------|-----|-----|-----|-----|-----|----|---|
| D22M3X D22N4, D30N4 | 240 | 420 | 214 | 206 | 403 | 10 | 6 |
| D37N4, D45N4 | 240 | 550 | 244 | 206 | 529 | 10 | 6 |

Dimensions in in.

| ATV212H | a | b | c | G | H | K | Ø |
|------------------------|------|-------|------|------|-------|------|------|
| D22M3X D22N4, D30N4 | 9.45 | 16.54 | 8.43 | 8.11 | 15.87 | 0.39 | 0.24 |
| D37N4, D45N4 | 9.45 | 21.65 | 9.60 | 8.11 | 20.83 | 0.39 | 0.24 |

EMC mounting plate (supplied with drive)

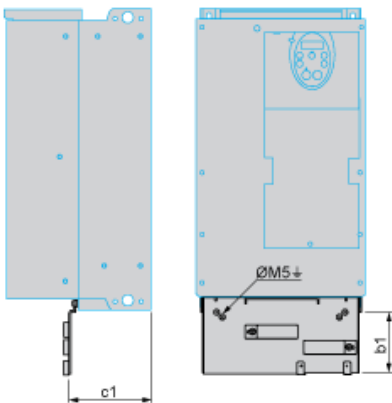

Dimensions in mm

| ATV212H | b1 | c1 |
|------------------------|-----|-----|
| D22M3X D22N4, D30N4 | 122 | 120 |
| D37N4, D45N4 | 113 | 127 |

Dimensions in in.

| ATV212H | b1 | c1 |
|------------------------|------|------|
| D22M3X D22N4, D30N4 | 4.80 | 4.72 |
| D37N4, D45N4 | 4.45 | 5.00 |

Mounting Recommendations

Clearance

Depending on the conditions in which the drive is to be used, its installation will require certain precautions and the use of appropriate accessories.

Install the unit vertically:

- Do not place it close to heating elements.
- Leave sufficient free space to ensure that the air required for cooling purposes can circulate from bottom to the top of the unit.

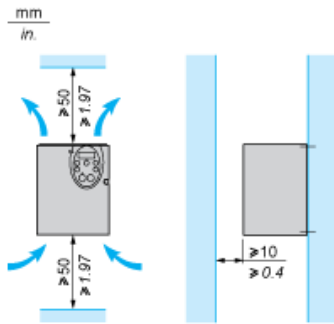

Mounting Types

Type A mounting

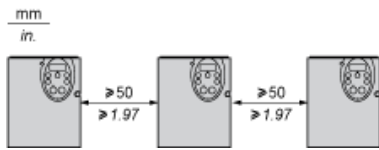

Type B mounting

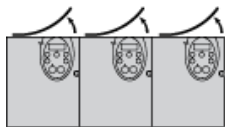

Type C mounting

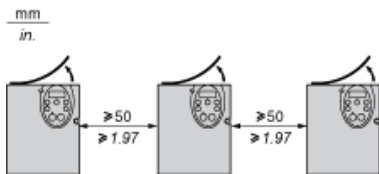

By removing the protective blanking cover from the top of the drive, the degree of protection for the drive becomes IP21. The protective blanking cover may vary according to the drive model, see opposite.

Specific Recommendations for Mounting in an Enclosure

To help ensure proper air circulation in the drive:

- Fit ventilation grilles.
- Check that there is sufficient ventilation. If there is not, install a forced ventilation unit with a filter. The openings and/or fans must provide a flow rate at least equal to that of the drive fans (refer to the product characteristics).

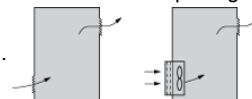

- Use special filters with UL Type 12/IP54 protection.
- Remove the blanking cover from the top of the drive.

Sealed Metal Enclosure (IP54 Degree of Protection)

The drive must be mounted in a dust and damp proof enclosure in certain environmental conditions, such as dust, corrosive gases, high humidity with risk of condensation and dripping water, splashing liquid, etc. This enables the drive to be used in an enclosure where the maximum internal temperature reaches 50°C.

Recommended Wiring Diagram

3-Phase Power Supply

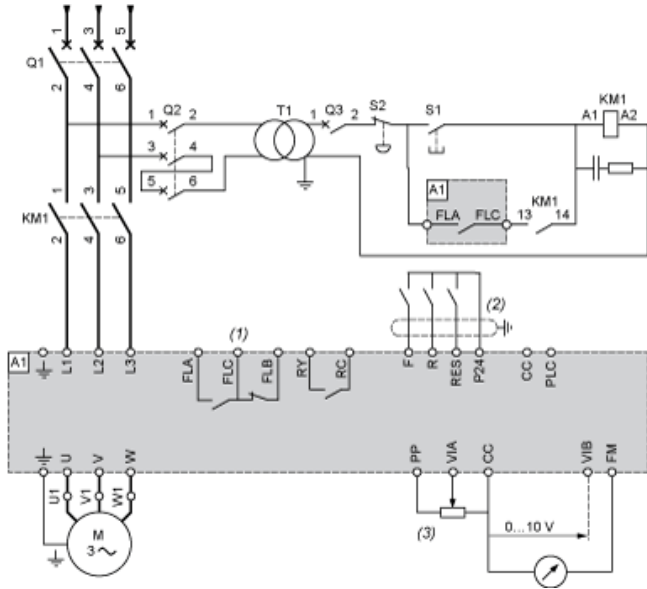

- A1: ATV 212 drive
- KM1: Contactor
- Q1: Circuit breaker
- Q2: GV2 L rated at twice the nominal primary current of T1
- Q3: GB2CB05
- S1, XB4 B or XB5 A pushbuttons
- S2:
- T1: 100 VA transformer 220 V secondary
- (1) Fault relay contacts for remote signalling of the drive status
- (2) Connection of the common for the logic inputs depends on the positioning of the switch (Source, PLC, Sink)
- (3) Reference potentiometer SZ1RV1202

NOTE: All terminals are located at the bottom of the drive. Install interference suppressors on all inductive circuits near the drive or connected on the same circuit, such as relays, contactors, solenoid valves, fluorescent lighting, etc.

Switches (Factory Settings)

Voltage/current selection for analog I/O (VIA and VIB)



Voltage/current selection for analog I/O (FM)



Selection of logic type



- (1) negative logic
- (2) positive logic

Other Possible Wiring Diagrams

Logic Inputs According to the Position of the Logic Type Switch

"Source" position

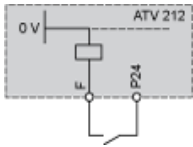

"Sink" position

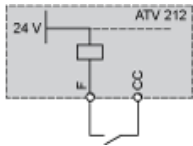

"PLC" position with PLC transistor outputs

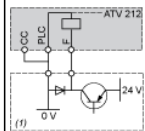

(1) PLC

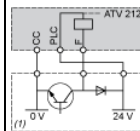

(1) PLC

2-wire control

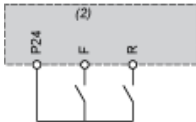

F: Forward

R: Preset speed

(2) ATV 212 control terminals

3-wire control

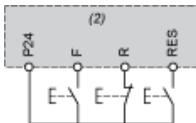

F: Forward

R: Stop

RES: Reverse

(2) ATV 212 control terminals

PTC probe

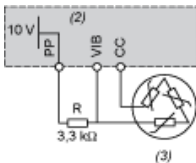

(2) ATV 212 control terminals

(3) Motor

Analog Inputs

Voltage analog inputs

External +10 V

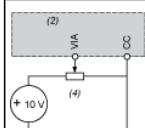

(2) ATV 212 control terminals

(4) Speed reference potentiometer 2.2 to 10 kΩ

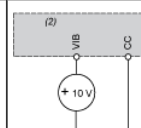

(2) ATV 212 control terminals

Analog input configured for current: 0-20 mA, 4-20 mA, X-Y mA

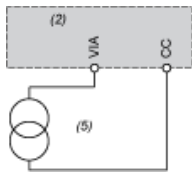

(2) ATV 212 control terminals

(5) Source 0-20 mA, 4-20 mA, X-Y mA

Analog input VIA configured as positive logic input ("Source" position)



(2) ATV 212 control terminals

Analog input VIA configured as negative logic input ("Sink" position)

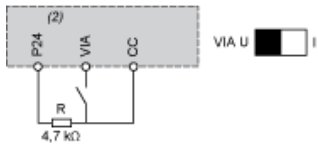

(2) ATV 212 control terminals

Derating Curves

The derating curves for the drive nominal current (I_n) depend on the temperature, the switching frequency and the mounting type (A, B or C). For intermediate temperatures (45°C for example), interpolate between 2 curves.

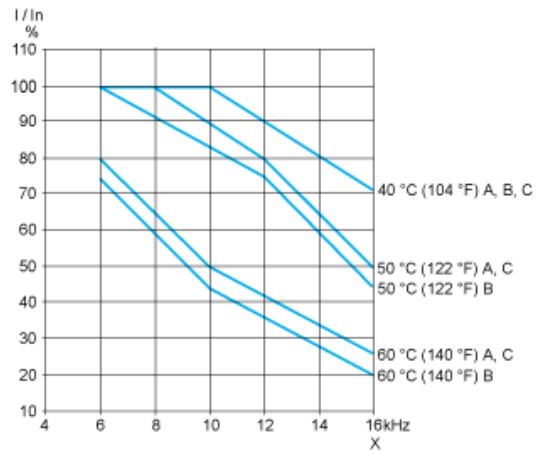

X Switching frequency